

FICHA TECNICA

PERNOS TORQUE CONTROLADO



A-490 F3125

Cap Screws & Bolts

Tension Control Bolts

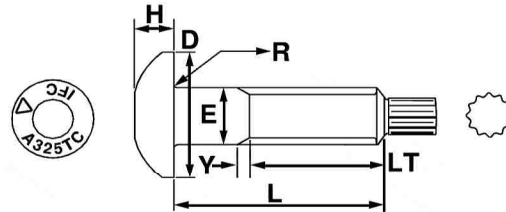

DIMENSIONS OF HIGH STRENGTH TENSION CONTROL BOLTS											
Nominal Bolt Size	E		D		H			R		LT	Y
	Body Diameter		Dia. of Bearing Surface		Height			Radius of Fillet		Thread Length (Ref)	Trans. Thread Length (Ref)
	Max.	Min.	Max.	Min.	Basic	Max.	Min.	Max.	Min.	Basic	Max.
5/8	0.642	0.605	1.181	1.102	25/64	0.403	0.378	0.062	0.021	1.25	0.22
3/4	0.768	0.729	1.417	1.338	15/32	0.483	0.455	0.062	0.021	1.38	0.25
7/8	0.895	0.852	1.654	1.535	35/64	0.563	0.531	0.062	0.031	1.50	0.28
1	1.022	0.976	1.900	1.771	39/64	0.627	0.591	0.093	0.062	1.75	0.31

HEAVY HEX NUTS USED WITH TENSION CONTROL BOLTS								
Nominal Nut Size	F			G		H		
	Width Across Flats			Width Across Corners		Height		
	Basic	Max.	Min.	Max.	Min.	Basic	Max.	Min.
5/8	1-1/16	1.062	1.031	1.227	1.175	39/64	0.631	0.587
3/4	1-1/41	1.250	1.212	1.443	1.382	47/64	0.758	0.710
7/8	1-7/16	1.438	1.394	1.660	1.589	55/64	0.885	0.833
1	1-5/8	1.625	1.575	1.876	1.796	63/64	1.012	0.956

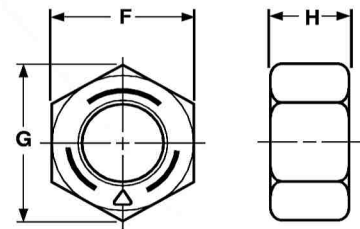

WASHERS USED WITH TENSION CONTROL BOLTS						
Nominal Bolt Size	D		d		t	
	Outside Diameter		Diameter of Hole		Thickness	
	Nom.	Tolerances	Nom.	Tolerances	Max.	Min.
5/8	1-5/16	- 1/32: + 1/4	11/16	- 0: + 1/32	0.177	0.122
3/4	1-15/32	- 1/32: + 1/4	13/16	- 0: + 1/32	0.177	0.122
7/8	1-3/4	- 1/32: + 1/4	15/16	- 0: + 1/32	0.177	0.136
1	2	- 1/32: + 1/4	1-1/8	- 0: + 1/32	0.177	0.136

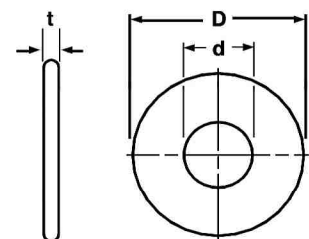

Description	A three piece fastening system consisting of: 1) a round-head bolt with a truncated, flat surface area at the top of the bolt, and a 24-sided tip which protrudes from the opposite end. The tip is calibrated to shear off when the proper tension is achieved; 2) a 2H heavy hex nut; and 3) a structural flat washer.		
Applications/ Advantages	Commonly used in structural steel joints in heavy construction. Has several advantages over traditional structural bolts, including: A) no operator or tool can over torque the fastening, B) the fastening can be visually inspected—when the tip is gone, the tension is correct; C) installation is faster, easier and can be done by one person; D) installation process is quieter.		
Component	<i>Bolt</i>	<i>Nut</i>	<i>Washer</i>
Material	Type 1 bolts shall be made from a carbon steel which conforms to the following chemical composition requirements-- <i>Carbon: 0.25-0.58%; Manganese: 0.60% minimum; Phosphorus: 0.048% maximum; Sulfur: 0.058% maximum</i>	2H nuts shall be made from a carbon steel which conforms to the following chemical composition requirements-- <i>Carbon: 0.40% minimum; Manganese: 1.00% maximum; Phosphorus: 0.040% maximum; Sulfur: 0.050% maximum; Silicon: 0.040% maximum</i>	Type 1 washers shall be made from a steel which conforms to the following chemical composition requirements: <i>Phosphorus: 0.050% maximum; Sulfur: 0.060% maximum</i>
Heat Treatment	Type 1 bolts shall be heat treated by quenching in a liquid medium from above the austenitizing temperature and then tempering by reheating to a temperature of at least 800°F.	2H nuts shall be heat treated to meet the required mechanical properties.	Washers shall be through hardened.
Hardness	5/8" through 1" diameter, inclusive: Rockwell C24 - 35	Rockwell C24 - 38	Rockwell C38 - 45
Proof Load	5/8" through 1" diameter, inclusive: 85,000 psi.	175,000 psi.	-
Yield Strength	5/8" through 1" diameter, inclusive: 92,000 psi. minimum	-	-
Tensile Strength	5/8" through 1" diameter, inclusive: 120,000 psi. minimum	-	-
Plating	All components are most commonly used plain, without any secondary finish other than oil.		

INSTALLATION PROCEDURE

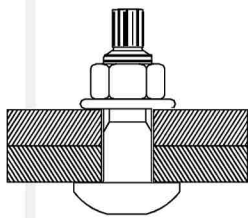

Place the bolt into the connection with the washer under the nut.

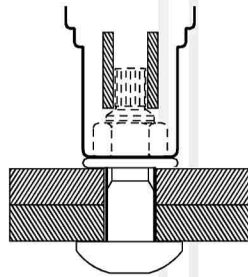

Slide the inner socket over the bolt tip and the outer socket over the nut. Press the trigger switch. The outer socket will rotate and tighten the nut until the bolt reaches the required tension.

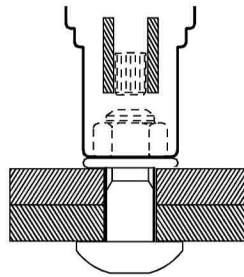

When the proper bolt tension is reached, the tip of the bolt will shear. When the tip of the bolt shears, pull back on the wrench until the outer socket is no longer engaging the nut.

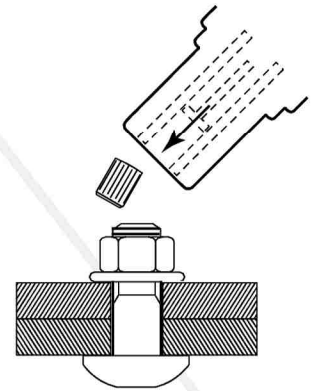

Push the ejector lever to discharge the severed bolt tip.